

FEATURES

- RoHS Compliant
- Sub-Miniature SIP & DIP Styles
- 3kVDC Isolation
- Efficiency up to 81%
- Wide Temperature performance at full 1 Watt load, -40°C to 85°C
- Increased Power Density to 2.09W/cm³
- UL 94V-0 Package Material
- Footprint at 0.69cm²
- Industry Standard Pinout
- 3.3V, 5V & 12V Input
- 3.3V, 5V, 9V, 12V and 15V Output
- No Heatsink Required
- Internal SMD Construction
- Fully Encapsulated with Toroidal Magnetics
- MTTF up to 2.4 Million hours
- Custom Solutions Available
- No Electrolytic or Tantalum Capacitors

DESCRIPTION

The NKE sub-miniature series of DC/DC Converters is particularly suited to isolating and/or converting DC power rails. A smaller package size, improved efficiency, lower output ripple and 3kVDC isolation capability through state of the art packaging and improved technology. The galvanic isolation allows the device to be configured to provide an isolated negative rail in systems where only positive rails exist. The wide temperature range guarantees startup from -40°C and full 1 watt output at 85°C.

SELECTION GUIDE

Order Code	Nominal Input Voltage	Output Voltage	Output Current	Input Current at Rated Load	Efficiency	Isolation Capacitance	MTTF ¹	Package Style
	(V)	(V)	(mA)	(mA)	%	pF	kHrs	
NKE0303DC	3.3	3.3	303	400	75	30	1234	DIP
NKE0305DC	3.3	5	200	400	76	35	632	
NKE0309DC	3.3	9	111	403	75	30	1204	
NKE0303SC	3.3	3.3	303	400	75	30	1234	SIP
NKE0305SC	3.3	5	200	400	76	35	632	
NKE0309SC	3.3	9	111	403	75	30	1204	
NKE0503DC	5	3.3	303	270	75	40	619	DIP
NKE0505DC	5	5	200	289	69	28	2414	
NKE0505DEC	5	5	200	250	78	34	419	
NKE0509DC	5	9	111	266	75	29	1173	
NKE0512DC	5	12	83	260	77	30	633	
NKE0515DC	5	15	66	256	78	32	360	
NKE0503SC	5	3.3	303	270	75	40	619	SIP
NKE0505SC	5	5	200	289	69	28	2414	
NKE0505SEC	5	5	200	250	78	34	419	
NKE0509SC	5	9	111	266	75	29	1173	
NKE0512SC	5	12	83	260	77	30	633	
NKE0515SC	5	15	66	256	78	32	360	
NKE1205DC	12	5	200	117	71	35	620	DIP
NKE1209DC	12	9	111	107	78	50	488	
NKE1212DC	12	12	83	105	79	57	360	
NKE1215DC	12	15	66	103	81	60	252	SIP
NKE1205SC	12	5	200	117	71	35	620	
NKE1209SC	12	9	111	107	78	50	488	
NKE1212SC	12	12	83	105	79	57	360	
NKE1215SC	12	15	66	103	81	60	252	

When operated **with** additional external load capacitance the rise time of the input voltage will determine the maximum external capacitance value for guaranteed start up. The slower the rise time of the input voltage the greater the maximum value of the additional external capacitance for reliable start up. NKE0505SEC/NKE0505DEC offers higher efficiency than NKE0505SC/NKE0505DC but over a narrower operating temperature range. See temperature characteristics graph.

INPUT CHARACTERISTICS

Parameter	Conditions	Min.	Typ.	Max.	Units
Voltage range	Continuous operation, 3.3V input types	2.97	3.3	3.63	V
	Continuous operation, 5V input types	4.5	5.0	5.5	
	Continuous operation, 12V input types	10.8	12.0	13.2	
Reflected ripple current	3.3V input types		40	60	mA p-p

ABSOLUTE MAXIMUM RATINGS

Short-circuit protection ²	1 second
Lead temperature 1.5mm from case for 10 seconds	300°C
Internal power dissipation	530mW
Input voltage V _{IN} , NKE03 types	5.5V
Input voltage V _{IN} , NKE05 types	7V
Input voltage V _{IN} , NKE12 types	15V

1. Calculated using MIL-HDBK-217F with nominal input voltage at full load.

2. Supply voltage must be disconnected at the end of the short circuit duration.

All specifications typical at T_A=25°C, nominal input voltage and rated output current unless otherwise specified.



OUTPUT CHARACTERISTICS					
Parameter	Conditions	Min.	Typ.	Max.	Units
Rated Power ¹	T _A =-40°C to 120°C			1.0	W
Voltage Set Point Accuracy	See tolerance envelope				
Line regulation	High V _{IN} to low V _{IN}		1.0	1.2	%/%
Load Regulation ²	10% load to rated load, 3.3V output types & 0309		10	15	%
	10% load to rated load, 5V output types		12	15	
	10% load to rated load, 9V output types		7.5	10	
	10% load to rated load, 12V output types		6.5	9.5	
	10% load to rated load, 15V output types		6.0	8.5	
Ripple and Noise	BW=DC to 20MHz, 3.3V output types & 0305, 0505SEC, 0505DEC		40	80	mV p-p
	BW=DC to 20MHz, other 5V output types		77	100	
	BW=DC to 20MHz, 9V output types		43	90	
	BW=DC to 20MHz, 12V output types		35	65	
	BW=DC to 20MHz, 15V output types		32	55	

ISOLATION CHARACTERISTICS					
Parameter	Conditions	Min.	Typ.	Max.	Units
Isolation test voltage	Flash tested for 1 second	3000			VDC
Resistance	Viso= 1000VDC		10		GΩ

GENERAL CHARACTERISTICS					
Parameter	Conditions	Min.	Typ.	Max.	Units
Switching frequency	All output types		115		kHz

TEMPERATURE CHARACTERISTICS					
Parameter	Conditions	Min.	Typ.	Max.	Units
Specification	All output types	-40		85	°C
Storage		-50		130	
Case temperature rise above ambient	0505D/S, 1205D/S			41	
	All other output types			32	
Cooling	Free air convection				

TECHNICAL NOTES					
<p>ISOLATION VOLTAGE</p> <p>'Hi Pot Test', 'Flash Tested', 'Withstand Voltage', 'Proof Voltage', 'Dielectric Withstand Voltage' & 'Isolation Test Voltage' are all terms that relate to the same thing, a test voltage, applied for a specified time, across a component designed to provide electrical isolation, to verify the integrity of that isolation.</p> <p>C&D Technologies NKE series of DC/DC converters are all 100% production tested at their stated isolation voltage. This is 1kVDC for 1 second.</p> <p>A question commonly asked is, "What is the continuous voltage that can be applied across the part in normal operation?"</p> <p>For a part holding no specific agency approvals, such as the NKE series, both input and output should normally be maintained within SELV limits i.e. less than 42.4V peak, or 60VDC. The isolation test voltage represents a measure of immunity to transient voltages and the part should never be used as an element of a safety isolation system. The part could be expected to function correctly with several hundred volts offset applied continuously across the isolation barrier; but then the circuitry on both sides of the barrier must be regarded as operating at an unsafe voltage and further isolation/insulation systems must form a barrier between these circuits and any user-accessible circuitry according to safety standard requirements.</p> <p>REPEATED HIGH-VOLTAGE ISOLATION TESTING</p> <p>It is well known that repeated high-voltage isolation testing of a barrier component can actually degrade isolation capability, to a lesser or greater degree depending on materials, construction and environment. The NKE series has toroidal isolation transformers, with no additional insulation between primary and secondary windings of enameled wire. While parts can be expected to withstand several times the stated test voltage, the isolation capability does depend on the wire insulation. Any material, including this enamel (typically polyurethane) is susceptible to eventual chemical degradation when subject to very high applied voltages thus implying that the number of tests should be strictly limited. We therefore strongly advise against repeated high voltage isolation testing, but if it is absolutely required, that the voltage be reduced by 20% from specified test voltage.</p> <p>This consideration equally applies to agency recognized parts rated for better than functional isolation where the wire enamel insulation is always supplemented by a further insulation system of physical spacing or barriers.</p>					

1. See Derating Graphs.

2. 12V input types have typically 3% less load regulation.

TEMPERATURE DERATING GRAPHS

NKE 0303DC/SC, 0305DC/SC, 0309DC/SC, 0503DC/SC, 0505DEC/SEC types only.

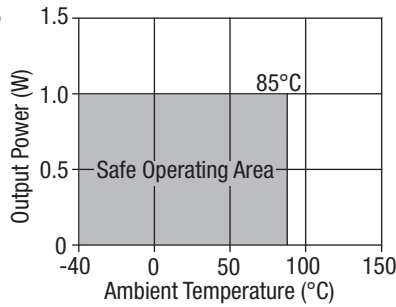

All other types.

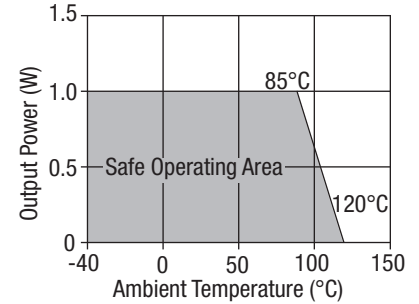

TOLERANCE ENVELOPES

3.3V output types.

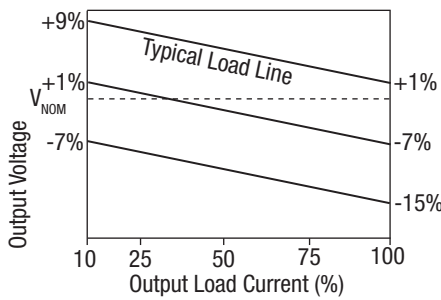

All other types.

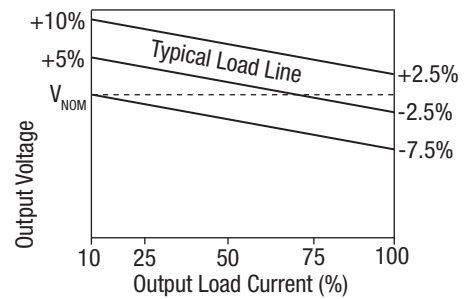

PACKAGE SPECIFICATIONS

MECHANICAL DIMENSIONS

DIP Package

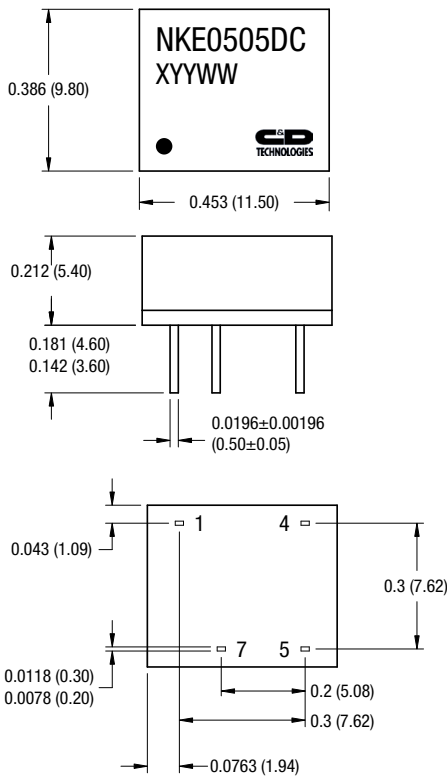

SIP Package

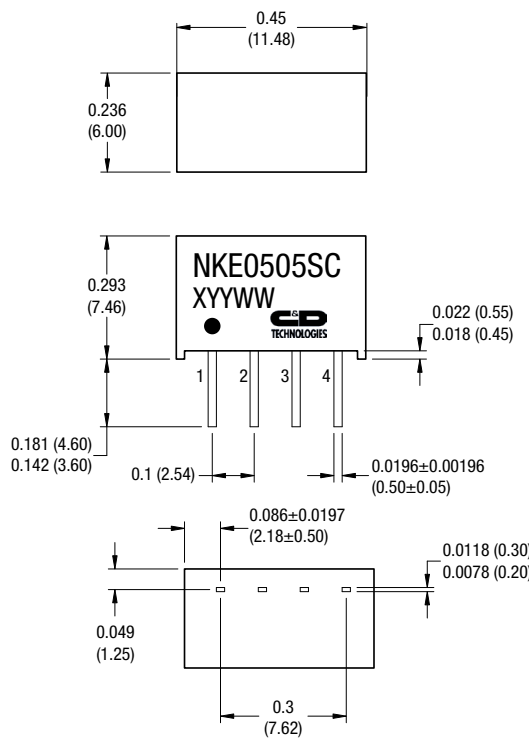

All dimensions in inches ±0.01 (mm ±0.25mm). All pins on a 0.1 (2.54) pitch and within ±0.01 (0.25) of true position.

Weight: 1.09g (SIP) 1.25g (DIP)

PIN CONNECTIONS - 8 PIN DIP

Pin	Function
1	-V _{IN}
4	+V _{IN}
5	+V _{OUT}
7	-V _{OUT}

PIN CONNECTIONS - 4 PIN SIP

Pin	Function
1	-V _{IN}
2	+V _{IN}
3	-V _{OUT}
4	+V _{OUT}

PACKAGE SPECIFICATIONS (continued)

RECOMMENDED FOOTPRINT DETAILS

8 Pin DIP Package

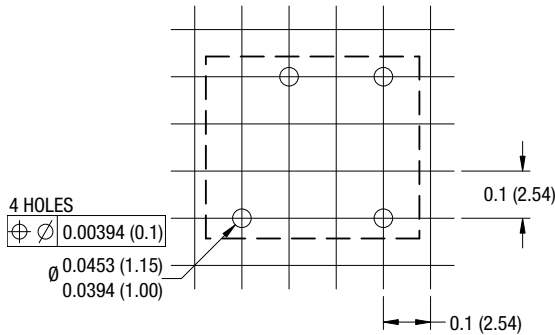

4 Pin SIP Package

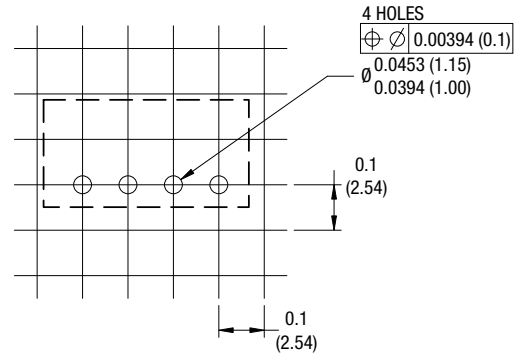

TUBE OUTLINE DIMENSIONS

8 Pin DIP Tube

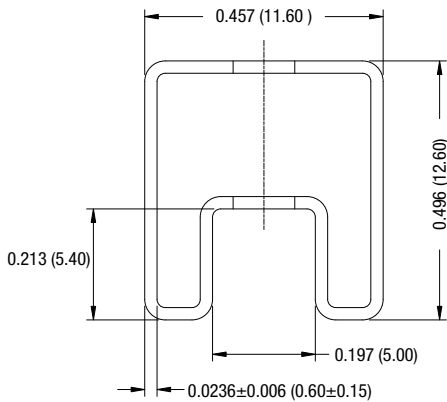

4 Pin SIP Tube

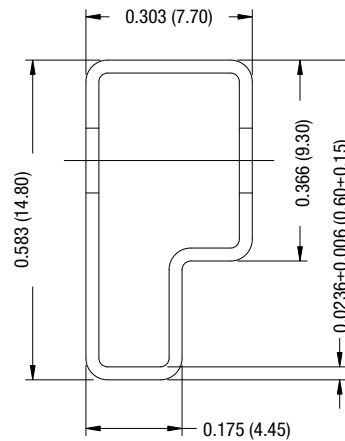

Unless otherwise stated all dimensions in inches (mm) ±0.5mm.
 Tube length (8 Pin DIP) : 20.47 (520mm ±2mm).
 Tube length (4 Pin SIP) : 20.67 (525mm ±2mm).

Tube Quantity : 40

RoHS COMPLIANCE INFORMATION



This series is compatible with RoHS soldering systems with a peak wave solder temperature of 300°C for 10 seconds. The pin termination finish on the SIP package type is Tin Plate, Hot Dipped over Matte Tin with Nickel Preplate. The DIP types are Matte Tin over Nickel Preplate. Both types in this series are backward compatible with Sn/Pb soldering systems.

For further information, please visit www.cd4power.com/rohs